

Varenummer: 201138008  
Beskrivelse: E+G Fingregreb  
GN 7336-42-M8-20-ST

## Mål

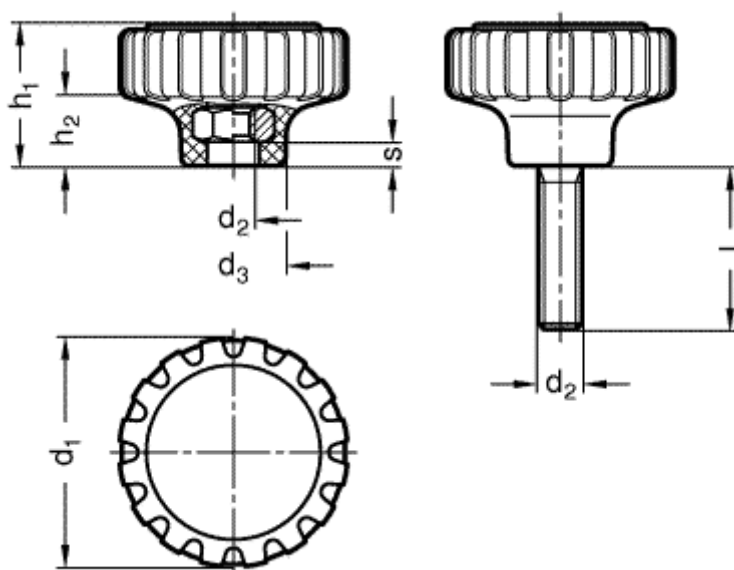

$d_1 = 42$   
 $d_2 = M 8$   
 $d_3 = 19$   
 $h_1 = 25$   
 $h_2 = 13$   
 $l = 20$   
 $s = 5$